

*The Spirit of Luxury*



GRAND INFLATABLE BOATS 2007



WELCOME TO THE OFFICIAL WEB SITE OF GRAND MARINE GROUP

[www.grandboats.com](http://www.grandboats.com)



GRAND MARINE GROUP

GRAND MARINE INTERNATIONAL INC.

14 Connie Cres., Unit 14, Concord, L4K2W8, Ontario, CANADA  
Tel: +1-905-7608519, Fax: +1-905-7608719, E-mail: [mail@grandboats.com](mailto:mail@grandboats.com)

# SILVER LINE Tenders

**S250**  
**S275**  
**S300**  
**S300S**  
**S330**  
**S330S**

BASE version

SPORT version

S300



S330S (SPORT version)



S300



S330S

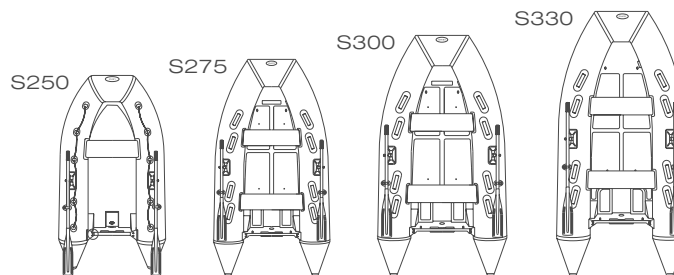

S300

model	Boat Length	Boat Width	Tube Diam.	Chambers	Passengers	Load MAX*	Engine MAX	Boat Weight
<b>S250</b>	250 cm 8' 2"	146 cm 4' 9"	38 cm 15"	3	2	330 kg 726 lbs	6 HP 4,4 kW	36 kg 79 lbs
<b>S275</b>	275 cm 9' 0"	155 cm 5' 1"	40 cm 16"	3	3	440 kg 968 lbs	10 HP 7,4 kW	45 kg 99 lbs
<b>S300</b>	300 cm 9' 10"	167 cm 5' 6"	43 cm 17"	3	4	520 kg 1144 lbs	15 HP 11 kW	55 kg 121 lbs
<b>S330</b>	330 cm 10' 10"	169 cm 5' 7"	43 cm 17"	3	4	580 kg 1276 lbs	20 HP 14,7 kW	70 kg 154 lbs

\* - Maximum load under Category D, 94/25/EC. For Category C - ask for details.

# SILVER LINE Riders

**S370**  
**S370S**  
**S370L**  
**S470**  
**S470S**  
**S470L**



S470L (with arch)

DE LUXE



SPORT



S370L



S470L steering console



Navigation arch (optional)



S470L

S370L

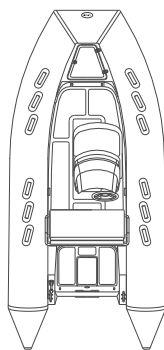
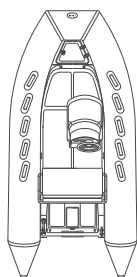

DE LUXE version compartments map

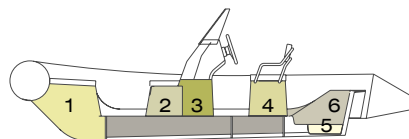

- 1 - Bow locker
- 2 - Console front locker
- 3 - Console rear locker
- 4 - Double seat locker
- 5 - Water collector
- 6 - Stern open storage volume

model	Boat Length	Boat Width	Tube Diam.	Chambers	Passengers	Load MAX*	Engine MAX	Boat Weight
<b>S370</b>	370 cm 12' 2"	185 cm 6' 1"	46 cm 18"	3	5+1	650 kg 1430 lbs	40 HP 29,4 kW	90 kg 198 lbs
<b>S470</b>	470 cm 15' 5"	205 cm 6' 9"	50 cm 20"	5	8	900 kg 1980 lbs	60 HP 44,1 kW	170 kg 374 lbs

\* - Maximum load under Category D, 94/25/EC. For Category C - ask for details.



S470L

# SILVER LINE Cruisers

**S550L**  
**S550GL**  
**S650L**  
**S650GL**



S650GL

S550GL



S650GL



model	Boat Length	Boat Width	Tube Diam.	Chambers	Passengers*	Load MAX*	Engine MAX
<b>S550</b>	550 cm 18' 1"	250 cm 8' 2"	55 cm 22"	5	10	1200 kg 2640 lbs	120 HP 88,3 kW
<b>S650</b>	650 cm 21' 4"	260 cm 8' 8"	55 cm 22"	5	12	1400 kg 3080 lbs	175 HP 128,7 kW

S650GL



S650GL with sundeck (optional)



\* - Maximum load under Category D, 94/25/EC. For Category C - ask for details.

# GOLDEN LINE Tenders

**G340L**  
**G340GL**  
**G380L**  
**G380GL**



G380GL

G340GL



G380GL



G340GL

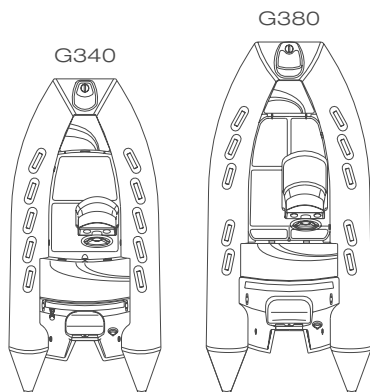

## Compartments map

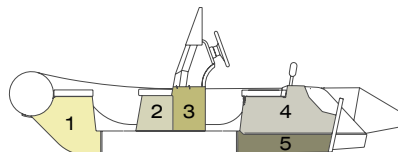

- 1 - Bow stowage locker
- 2 - Console front locker
- 3 - Console rear locker
- 4 - Rear seat stowage compartment
- 5 - Bilge pump / drainage compartment

	Boat Length	Boat Width	Tube Diam.	Chambers	Passengers	Load MAX*	Engine MAX	Boat Weight
model								
<b>G340</b>	340 cm 11' 2"	172 cm 5' 8"	43 cm 17"	3	4	580 kg 1276 lbs	25 HP 18,4 kW	110 kg 242 lbs
<b>G380</b>	380 cm 12' 6"	182 cm 6' 1"	46 cm 18"	3	5	650 kg 1430 lbs	40 HP 29,4 kW	160 kg 352 lbs



G380GL

\* - Maximum load under Category D, 94/25/EC. For Category C - ask for details.

# GOLDEN LINE Riders

**G480L**  
**G480GL**



G480GL



Picnic table (optional)



Compartments map

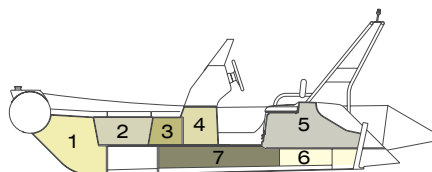

- 1 - Bow locker with soft seat
- 2 - Bow side compartment
- 3 - Steering console front locker
- 4 - Steering console rear locker with hitch
- 5 - Main rear storage compartment
- 6 - Technical compartment (for bilge pump)
- 7 - Built-in fuel tank compartment



G480GL

model	Boat Length L	Boat Width B	Tube Diam. D	Chambers	Passengers	Load MAX* W	Engine MAX HP max	Boat Weight W
G480	480 cm 21' 4"	205 cm 6' 9"	51 cm 20"	5	6	900 kg 1980 lbs	75 HP 55,2 kW	265 kg 583 lbs

\* - Maximum load under Category D, 94/25/EC. For Category C - ask for details.

# RANGER Sport & PRO Boats

**R380**  
**R380PRO**  
**R420**  
**R420PRO**  
**R460**  
**R460PRO**

SPORT  
 PRO



R420 (with CS-02)



R460PRO

R420



Optional console CS-02

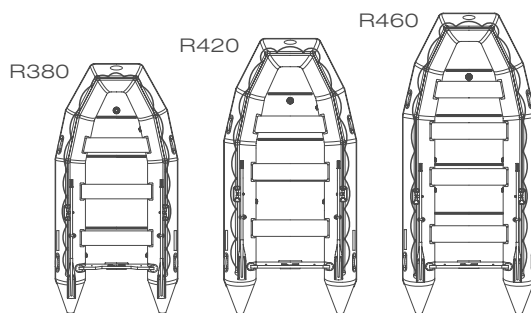

R460PRO (with optional arch)



model	Boat Length	Boat Width	Tube Diam.	Chambers	Passengers	Load MAX*	Engine MAX	Boat Weight
<b>R380</b>	380 cm 12' 6"	190 cm 6' 3"	46 cm 18"	3+1	7	700 kg 1550 lbs	30 HP 22,1 kW	78 kg 172 lbs
<b>R420</b>	420 cm 13' 9"	205 cm 6' 9"	48 cm 19"	5+1	9	900 kg 1980 lbs	40 HP 29,4 kW	92 kg 202 lbs
<b>R460</b>	460 cm 15' 1"	205 cm 6' 9"	48 cm 19"	5+1	10	1000 kg 2200 lbs	50 HP 36,8 kW	105 kg 231 lbs

\* - Maximum load under Category D, 94/25/EC. For Category C - ask for details.



R420

# CORVETTE Foldable Sportboats

**C240**  
**C270**  
**C300**  
**C330**  
**C360**



C330

C300



C360



C330

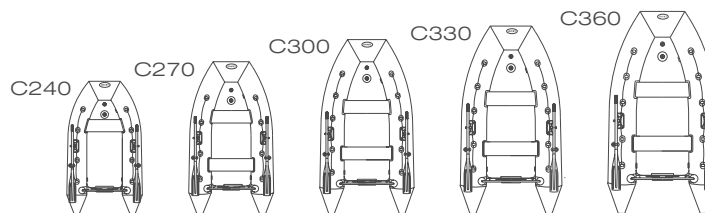

C360

model	model	Length	Width	Tube diam.	Chambers	Passengers	Load MAX*	Engine MAX	Boat weight
FLOOR BOARDS	AIR DECK								
C240	C240A	240 cm 7' 10"	140 cm 4' 7"	36 cm 14"	3+1/3+2	2+1	300 kg 660 lbs	5 HP 3,7 kW	35/27 kg 77/59 lbs
C270	C270A	270 cm 8' 10"	150 cm 4' 11"	40 cm 16"	3+1/3+2	3	400 kg 880 lbs	10 HP 7,4 kW	45/32 kg 99/70 lbs
C300	C300A	300 cm 9' 10"	170 cm 5' 7"	43 cm 17"	3+1/3+2	4	520 kg 1144 lbs	15 HP 11 kW	55/40 kg 121/88 lbs
C330	C330A	330 cm 10' 10"	170 cm 5' 7"	43 cm 17"	3+1/3+2	4	600 kg 1320 lbs	20 HP 14,7 kW	65/50 kg 143/110 lbs
C360	C360A	360 cm 11' 10"	184 cm 6' 0"	46 cm 18"	3+1/3+2	5	700 kg 1540 lbs	30 HP 22,1 kW	78/60 kg 172/132 lbs

\* - Maximum load under Category D, 94/25/EC. For Category C - ask for details.

# ELF Foldable Dinghies

**E210**  
**E240**  
**E270**  
**E300**



E270

E240









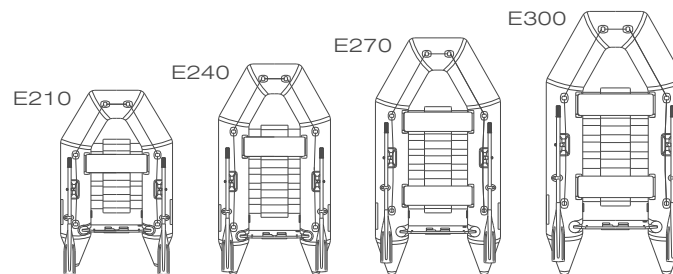

E240



E270



model	Boat Length 	Boat Width 	Tube Diam. 	Chambers 	Passengers 	Load MAX* 	Engine MAX 	Boat Weight 
E210	210 cm 6' 11"	128 cm 4' 2"	34 cm 13"	2	2	220 kg 484 lbs	4 HP 2,9 kW	22 kg 48 lbs
E240	240 cm 7' 10"	128 cm 4' 2"	34 cm 13"	2	3	270 kg 594 lbs	5 HP 3,7 kW	26 kg 57 lbs
E270	270 cm 8' 10"	143 cm 4' 8"	37 cm 15"	2	3	350 kg 770 lbs	8 HP 5,9 kW	31 kg 68 lbs
E300	300 cm 9' 10"	158 cm 5' 2"	40 cm 17"	2	4	540 kg 1188 lbs	10 HP 7,4 kW	42 kg 92 lbs



E240

\* - Maximum load under Category D, 94/25/EC. For Category C - ask for details.



# ACCESSORIES & OPTIONAL EQUIPMENT



Steering console CL-01



Steering console CL-02



Steering console CL-03



Steering console CL-04



Cruising bar SD-04 with 2 seats & table



Steering console CS-01



Steering console CS-02



Double seats SD-01, SD-02, SD-03



Boat overall cover



Boat Cleaning and Protection Kit



1. SPEEDCLEAN — active cleaner for PVC and HYPALON GRAND boats.
  2. POLYGUARD — polymer protector against dirt, oil, UV, environment etc.
- They are only products approved by GMG for maintenance of GRAND inflatable boats.

Keel and tube protection system

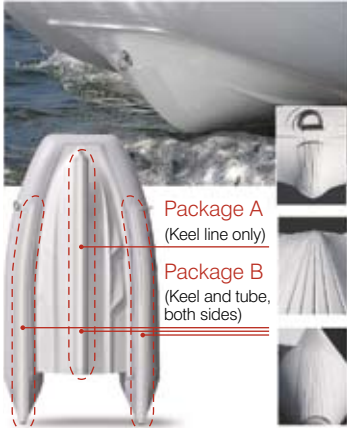

Package A  
(Keel line only)

Package B  
(Keel and tube,  
both sides)

Bow storage bag



Seat cushion with under-seat bag



3-arch collapsible suntop



Carry bags Small, Medium, Large



Single frame heavy-duty navigation arch for RANGER series



Stainless steel navigation arch for S470

